

# CANDELA



## C-8

Electric long-range  
and performance

Made in Sweden.



# C-8

## The first modern watercraft

All other boats just became obsolete. Candela C-8 breaks existing rules and sets new ones.

Merging advanced aircraft technology with software and electronics, C-8 flies above the waves in silence.

Consuming just a fraction of the energy conventional boats use, C-8 is the first true long-range electric cruiser. But that's just the beginning.





# 50+

Range in nautical miles at 22 knots.

# 30

Top speed in knots.

Since we dreamed of going faster and farther, we had to learn how to fly. A flying boat provides a dramatically more efficient way of moving, but also a truly elevated driving experience.

# 0

Emissions per nautical mile.

## Zero emissions

Fossil-fuel freedom

## Zero noise

Electric pod motor

## Zero slamming

As well as zero wake





# UI



6

## Fully integrated

The helm position of C-8 is simple and clean, with a 15.4-inch touch-screen running Candela's intuitive UI.

Control everything - from cooler to navigation - from the screen or the Candela app.

We believe in seamless machine-human interaction, and pride ourselves on delivering the best user experience of any boat. Over-The-Air updates keeps your C-8 up to date over the craft's lifetime.

Control everything - from the cooler to navigation - from the screen of your Candela app.





# Simply a better experience

8

In order to make a truly compelling electric craft, we had to rethink boats.

Instead of punching its way through the waves, C-8 flies silently above the surface. Instead of fitting a bigger engine, we went for dramatically improved efficiency by developing a pod motor optimized for hydrofoils. Instead of creating huge swells, we made a craft that leaves no wake behind.

Cruise at 30 knots on pure electric power. With a range of 57 nautical miles at a speed of 22 knots, the C-8 has the endurance needed for long adventures.





# One boat, endless possibilities

The Candela C-8 comes in a range of configurations to suit every need. With a sleek design, top-of-the-line features, and unparalleled performance, our three models have you covered. Whether you are looking to spend a relaxing day on the water or tackle choppy seas, our boats will give you an unforgettable experience. Check out the daycruiser, the hardtop, and the T-Top, to find the perfect boat for your next adventure.

The T-Top is the ultimate combination of adventure and comfort. With a large sunshade and plenty of seating, it's perfect for long days on the water, cruising, fishing or simply relaxing.



The open daycruiser is perfect for soaking up the sun and enjoying the scenery. With plenty of seating and a large sunbed, it's great for picnics, family gatherings, and lazy days on the water.



The hardtop is a more rugged experience, featuring a spacious cabin with good headroom, protecting you from the elements. In sunny weather, you can open the retractable canvas roof and let the sunshine in.



# Tech Trinity

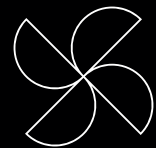

## Flight Controller

A flying boat with submerged foils needs active stabilization. Candela C-8's Flight Controller works in a similar fashion to the Flight Controller in a modern jet fighter. Several different types of sensors, such as a gps, accelerometer, and gyro, measure the boat's position in space.

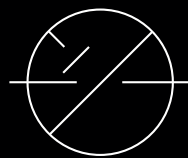

Using this input, the onboard computer - the Flight Controller - determines how the foils should be angled to maintain the optimum flight height and roll angle. The system makes for a superior ride experience compared to conventional boats. All software and hardware are developed in-house by Candela's strong engineering team.

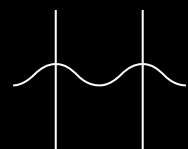

## Candela C-POD

Candela C-POD is the most efficient and silent boat propulsion ever. The electric, direct-drive, submerged motor provides ample thrust and a top speed of 30 knots, while the absence of mechanical transmission eliminates the need for maintenance.

Candela C-POD is the first electric pod motor designed for high-speed boats. It reduces friction to a minimum and provides 23% more range than the best electric outboards. By placing the ultra-silent motor under the water, we get rid of the already low noise from the drivetrain, creating the most silent electric boats on the market, at any speed.

## Candela C-FOIL

Hydrofoils remove 50% of the drag compared to a planing boat. This is the most important principle in our design. Hydrofoils can be designed in different ways with varying efficiencies and behavior. We opted for the most efficient and precise solution, fully submerged foils. Other types of foiling systems are less efficient and are therefore not suitable for electrification.

Similar to a traffic airplane: Candela's craft uses a large, straight main foil close to its center of gravity and a smaller aft T-foil.

The foils are retractable for trailing, storage, and shallow water operation.



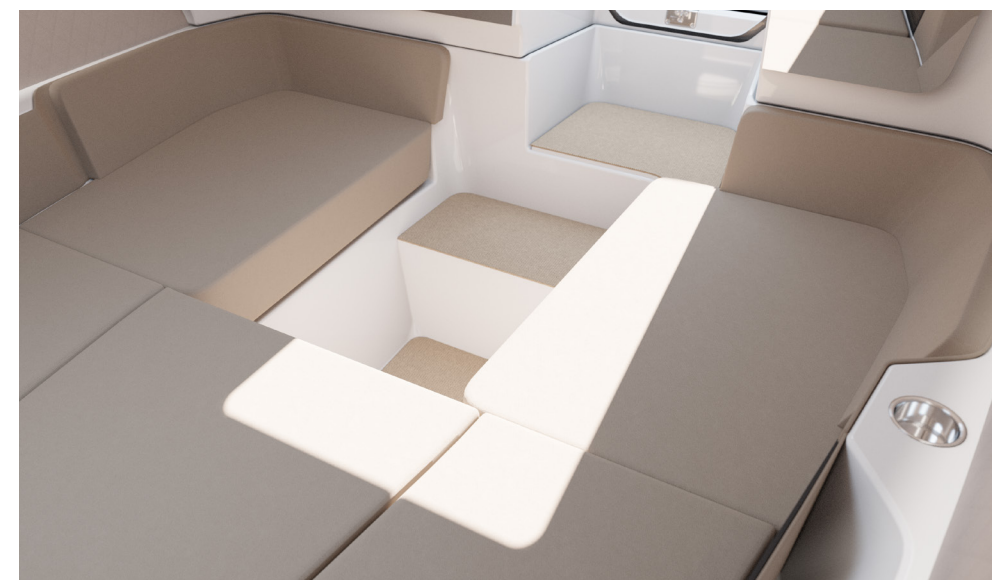
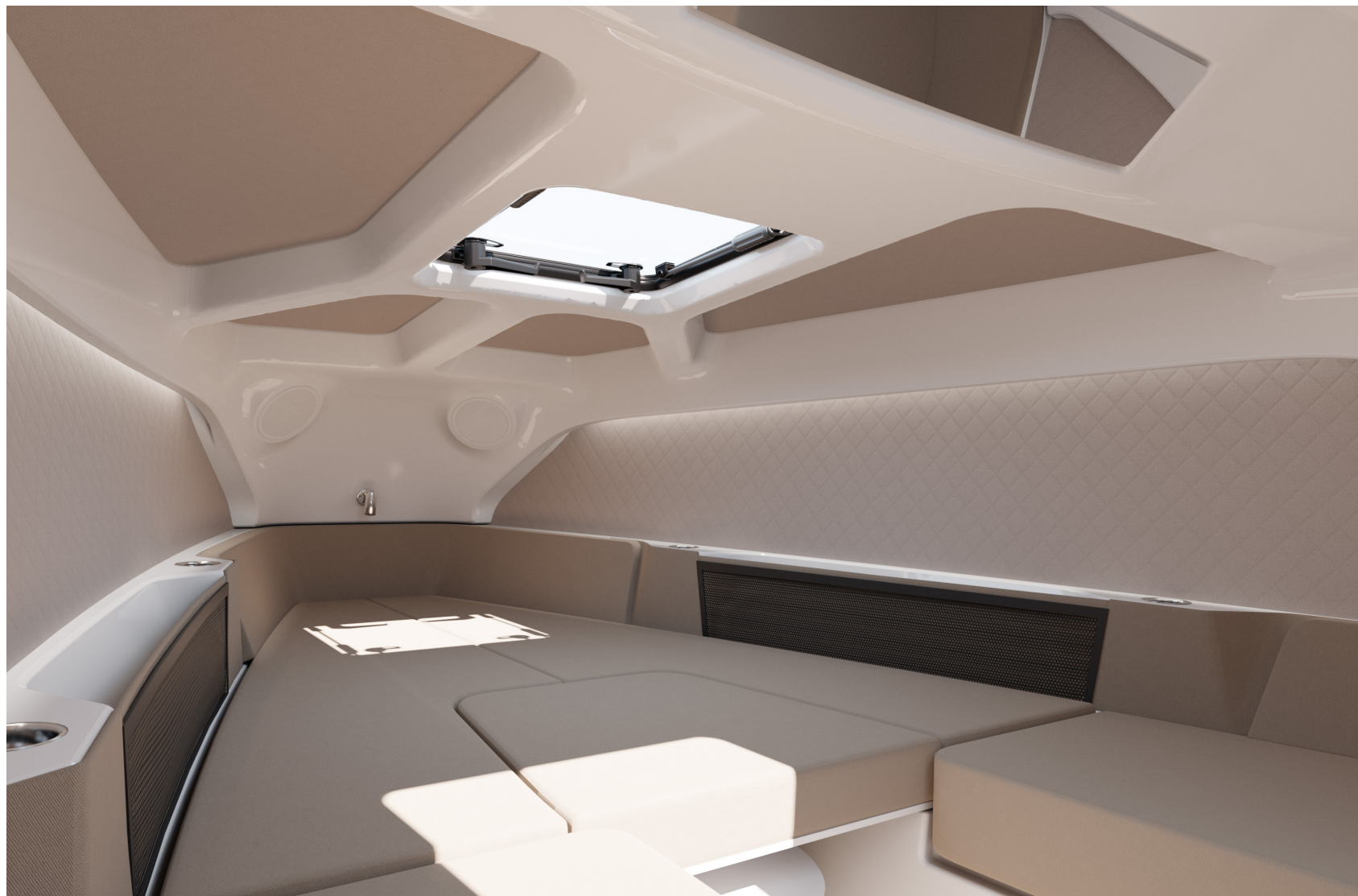

Ample storage, a marine head and dimmable LED lights provide full comfort for overnight trips.

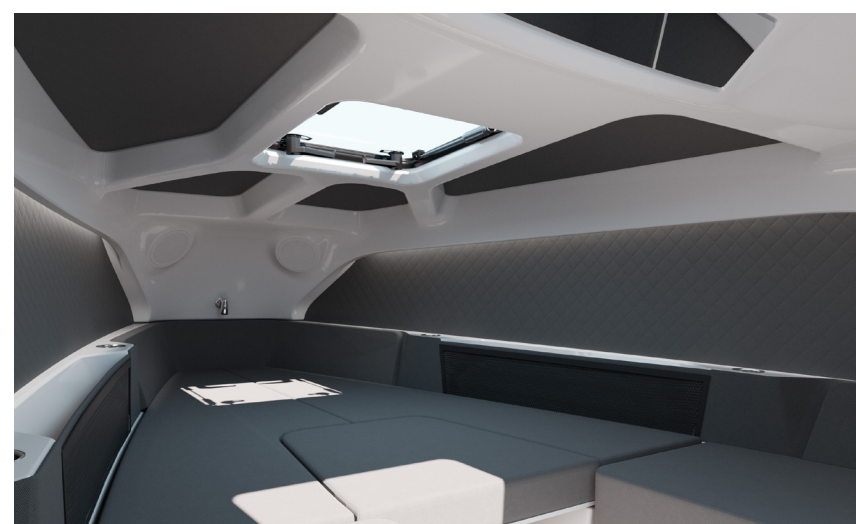

A tinted window in the ceiling provides just the right amount of natural light.

## Superior interior and comfort

The cabin in the C-8 is a great place to relax. A premium sound system with subwoofer and six speakers allow for a unique concert experience on board the most silent electric craft ever made.



# Fully retractable

In shallow mode, the foils and C-POD are hoisted up and protected by the hull, so you can explore natural harbors without worrying about damaging the propeller. In extreme weather conditions that prevent foiling, C-8 can be driven as a conventional planing boat, albeit with reduced range.

In harbor mode, the foils fully retract above the water surface and are therefore protected from fouling and corrosion. This mode also makes C-8 trailerable and compatible with boat lifts.

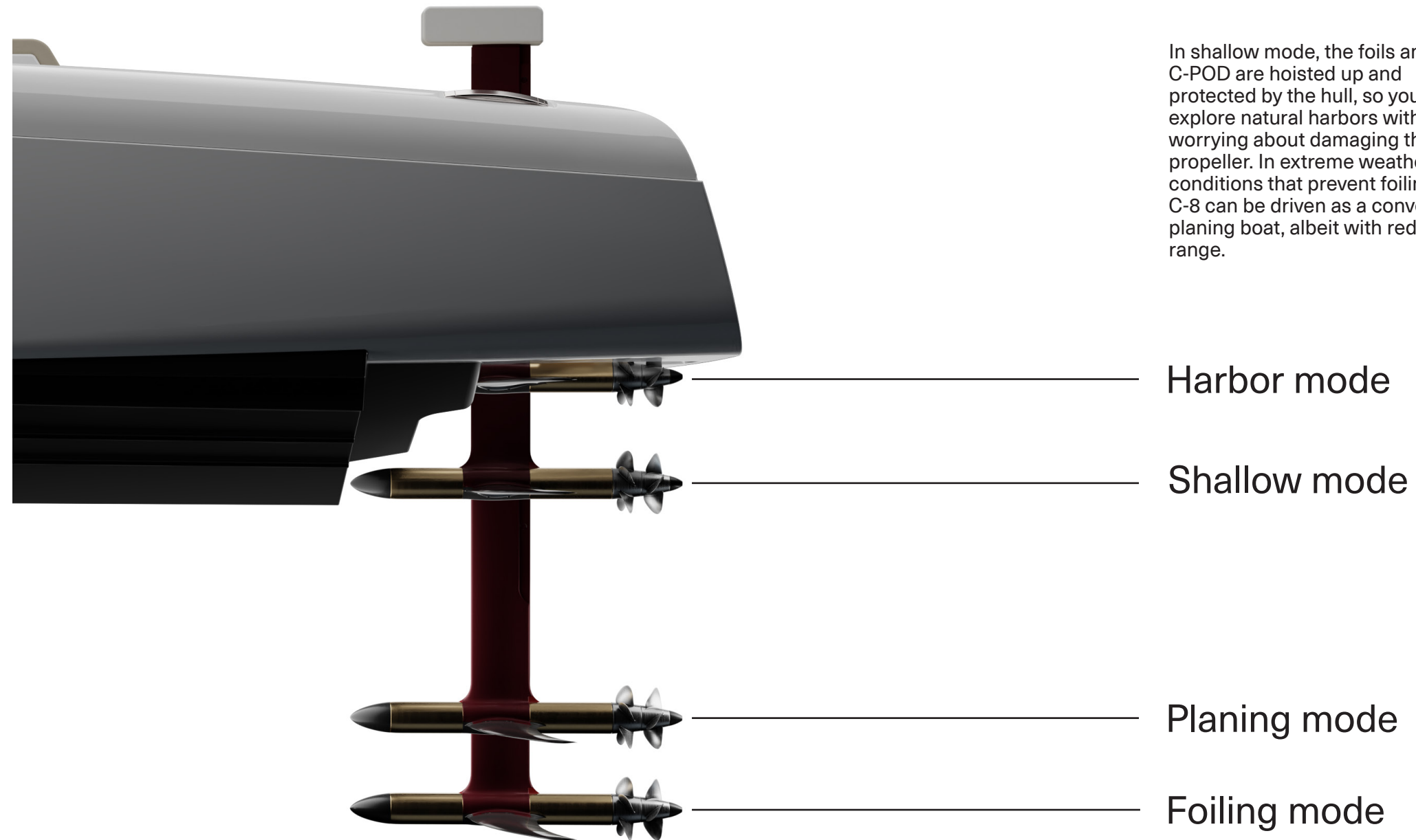

The retractable C-FOIL system makes C-8 a true no-compromise electric boat.



# A better craft for a better world

C-8 is a long-range, all-electric craft that travels silently above the surface. No emissions. No sound pollution or disturbance of marine life.

We designed it to be the most efficient boat ever built. At 20 knots, the energy usage per nautical mile is just 0,8 kWh. To put that into perspective, that's the energy content of 0,1 liter of gasoline.

All Candela boats regularly receive over-the-air software updates that add new features and enhance existing ones over the boat's cellular network.

## Specifications Candela C-8

We have made the Candela C-8 extremely light, while still highly impact resistant.

Check out the specifications on the right.

Material	Carbon fiber
Weight	1750 kg DC version
Passengers	8 passengers including driver
Length	8.50 m
Beam	2.50 m
Speed	22 kn cruise, 30 kn top
Motor	Candela C-POD (45/50 kW)
Range	57 NM at cruising speed +3 NM at 4 kn in limp mode home
Draft	0.5 m in shallow mode 0.9 m in planing mode 0.8 m while foiling 1.5 m while not foiling, foils extended
Charging	230Vx1x16A: 12 h 400Vx3x16A: 5.5 h DC CCS2 350kW: <1 h  DC CCS1 150kW: <1 h 120Vx1x80A: 6.25 h
Interface	15.4-inch touch screen with Candela's proprietary navigation and boat integration system. Free software upgrades included. One year free sea chart upgrades included.
App	Candela app with position, state of charge, route statistics and more. Optional geo-fence.
Hull-shape	The hybrid hull is shaped for frictionless planing in addition to low air resistance when foiling. In harbor mode the front and rear foils are above the water surface, which prevents fouling and corrosion.
Sound	6 x waterproof speakers + subwoofer, including audio playback via Bluetooth.
Variants	Available in open day cruiser or covered hard top version.
Colors	Gray and white.
Control	Take off, cruise, and landing are all fully automated.



